

MARINE CATALOG

Steele
RUBBER PRODUCTS®

Quality Crafted
Rubber Parts &
Weatherstripping



HATCH SEALS
CABIN DOOR SEALS
RUB RAIL INSERT KITS
LIVWELL SEALS
INSERT TRIM
RUBBER EDGING
PEEL-N-STICK RUBBER
WINDSHIELD TRIM RUBBER

steelerubber.com



THIS IS YOUR MARINE CATALOG

Thank you for trusting Steele Rubber Products with the protection of your marine vessel.

Here at Steele Rubber Products, we've been making quality crafted rubber parts and weatherstripping since 1958. We're a family run business now in its third generation and we continue to proudly manufacture in the United States!

Our goal is to provide you the best quality and fitting seals and weatherstripping available on the market. Learn more about us and everything we offer by visiting our website at steelerubber.com.

HOW TO USE THIS CATALOG

We've done a lot of research to make this catalog easy to use and it's designed to help you find what parts you need. Grouped into specific categories, each part is presented with a profile silhouette and exact dimensions to help you identify the correct shape and size, ensuring the best fit.

We are so determined in finding you the best solution, we even offer samples of our seals before you make the decision to buy. If at any time you need assistance, our team of Product Specialists are here to help.

HOW TO ORDER

GO TO STEELERUBBER.COM

↓

SEARCH FOR PART NUMBER

→

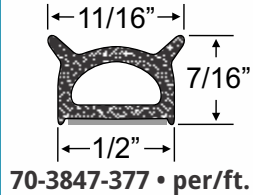

70-3847-377 • per/ft.

OR CALL

888-578-5897

8am-6pm Eastern

CONTACT US

EMAIL
marine@steelerubber.com

MAIL
6180 E NC 150 HWY
DENVER, NC 28037



Proud Members Of





MARINE WEATHERSTRIPPING

- **CABIN & COMPARTMENT DOOR SEALS** 2-5
- **WINDOW & GLASS SEALS** 6-8
- **HATCH SEALS** 9-11
- **EDGE TRIM & DOCK EDGING** 12
- **RUB RAIL INSERT KITS** 13
- **INSERT TRIM, DRIP RAILS & MISC. PARTS** 14
- **DRIPPER GUARD** 15
- **BUMPERS, GROMMETS & PLUGS** 16
- **ROOF MOUNTED AC/HEAT PUMP GASKET** 17
- **TOOLS & ADHESIVES** 18-19



Steele Rubber Products 6180 E NC 150 HWY Denver NC 28037

steelrubber.com

888-578-2237



Cabin & Compartment Door Seals

Steele Rubber Products offers a variety of seals for your cabin and compartment doors. These extruded seals feature either the weather resistant 3M Peel-N-Stick adhesive or push-on attachment designs to best accommodate your needs. Our high-quality EPDM rubber makes for a durable and secure fit between the door and frame that is easy to install.



Call or visit our website for current pricing

Sponge Rubber Peel-N-Stick Seals

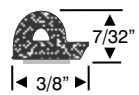

83-0102-377 • 5ft.
83-0103-377 • 10ft.
83-0124-377 • 15ft.
83-1016-377 • 30ft.

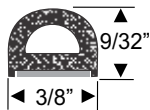

83-0104-377 • 5ft.
83-0105-377 • 10ft.
83-0106-377 • 15ft.
83-1017-377 • 30ft.

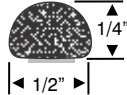

83-0127-377 • 5ft.
83-0113-377 • 10ft.
83-0114-377 • 15ft.
83-1018-377 • 30ft.

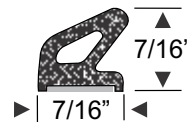

83-0128-377 • 5ft.
83-0129-377 • 10ft.
83-0119-377 • 15ft.
83-1022-377 • 30ft.

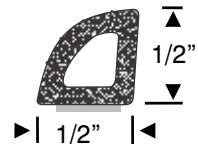

83-0125-377 • 5ft.
83-0126-377 • 10ft.
83-0122-377 • 15ft.
83-1021-377 • 30ft.

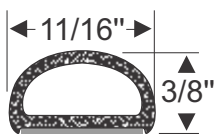

70-3848-377 • per/ft.

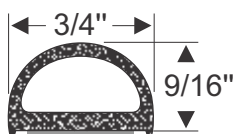

70-3859-377 • per/ft.

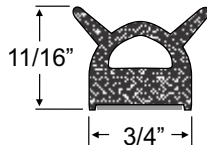

70-3802-377 • per/ft.

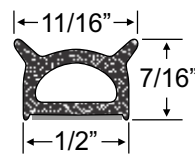

70-3847-377 • per/ft.

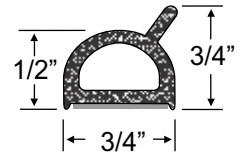

70-3984-377 • per/ft.

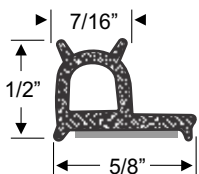

70-3852-372 • per/ft.

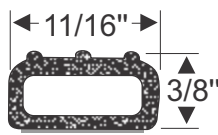

70-3849-377 • per/ft.

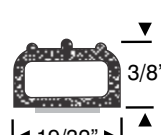

70-3676-377 • per/ft.

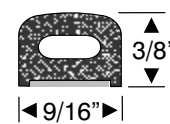

83-0109-377 • 5ft.
83-0110-377 • 10ft.
83-0111-377 • 15ft.
83-1020-377 • 30ft.

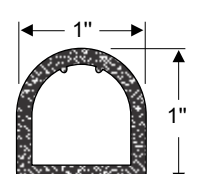

70-3850-377 • per/ft.

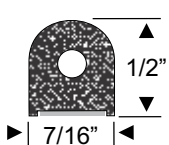

83-0107-377 • 5ft.
83-0108-377 • 10ft.
83-0130-377 • 15ft.
83-1019-377 • 30ft.

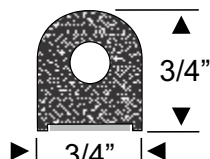

83-1023-377 • 5ft.
83-1024-377 • 10ft.
83-1025-377 • 15ft.
83-1026-377 • 30ft.

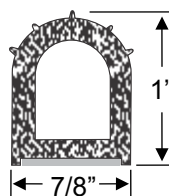

70-3677-377 • per/ft.

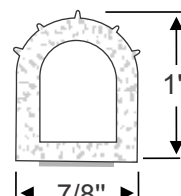

WHITE SPONGE RUBBER
70-3850-377 • per/ft.

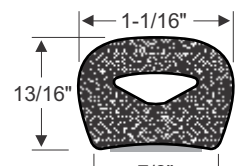

70-3972-372 • per/ft.

Cabin & Compartment Door Seals Sponge Rubber Peel-N-Stick Seals

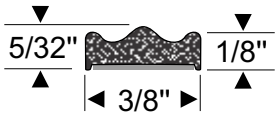

70-4624-377
per/ft.

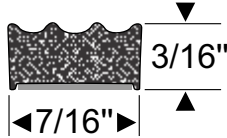

70-3846-377
per/ft.

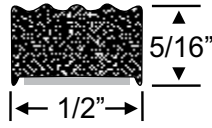

70-3672-377
per/ft.

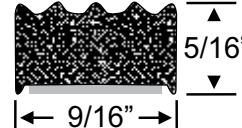

70-3673-377
per/ft.

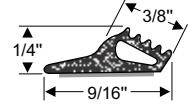

70-3858-377
per/ft.

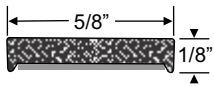

70-4205-372 • per/ft.

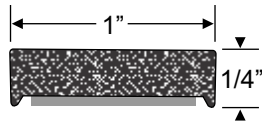

70-4204-377 • per/ft.

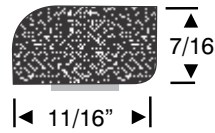

30-0243-377 • per/ft.

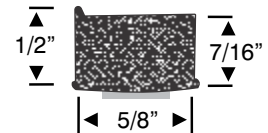

30-0144-377 • per/ft.

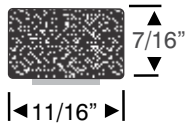

70-1105-377 • per/ft.

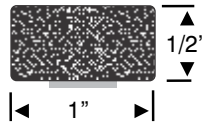

70-1106-377 • per/ft.

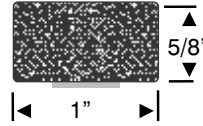

70-0129-377 • per/ft.

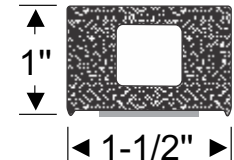

70-3872-345 • per/ft.

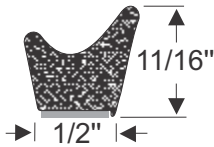

70-0145-377 • per/ft.

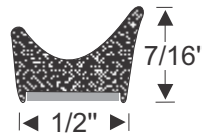

70-0331-372 • per/ft.

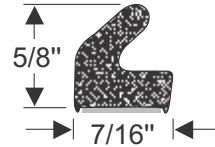

40-0480-377 • per/ft.

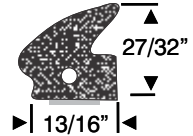

83-0123-377 • 10ft.

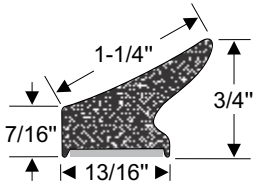

70-4504-377
per/ft.

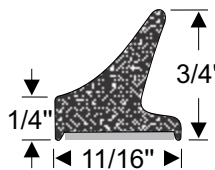

70-1437-377
per/ft.

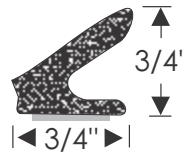

70-2401-377
per/ft.

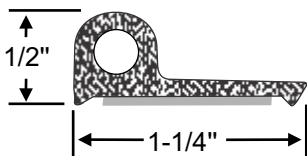

70-3708-372
per/ft.

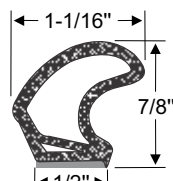

70-2431-372
per/ft.

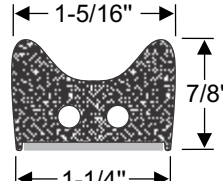

70-4644-345
per/ft.



Call or visit our website for current pricing

Cabin & Compartment Door Seals

Push-On Seals

Side Bulb

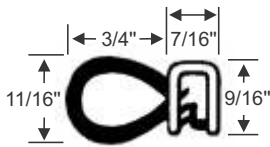

FOR 1/16" TO 1/8" EDGES
70-3582-377 • per/ft.

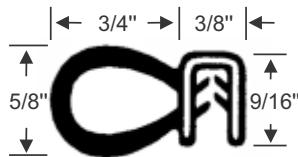

FOR 3/16" TO 1/4" EDGES
70-3583-377 • per/ft.



FOR 3/16" TO 1/4" EDGES
70-3584-345 • per/ft.

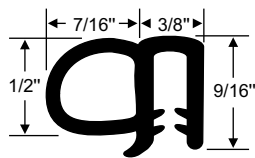

FOR 1/8" EDGES
70-3592-377 • per/ft.

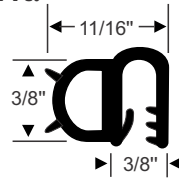

FOR 1/8" EDGES
70-3855-377 • per/ft.

Top Bulb

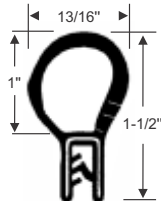

FOR 1/8" EDGES
70-3587-377 • 25 ft. Strip

Side Lip

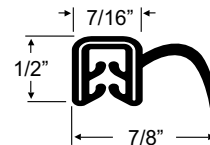

FOR 1/16" TO 1/8" EDGES
70-3801-377 • per/ft.

Glue-On Seals - Sponge



30-0470-377 • per/ft.

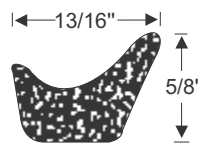

50-0085-372 • per/ft.



70-0219-372 • per/ft.

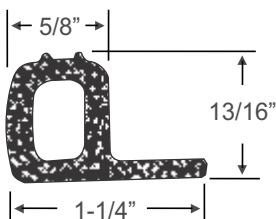

70-3803-377 • per/ft.

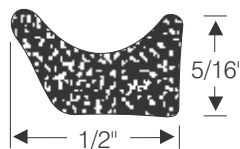

70-1789-377 • per/ft.





70-0311-372 • per/ft.

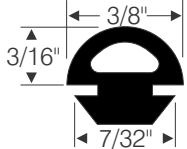
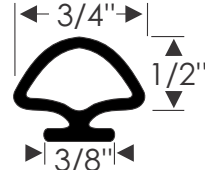
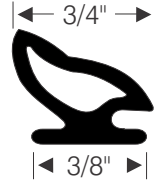
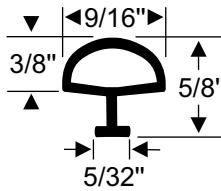
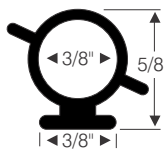
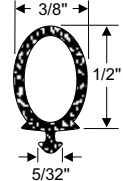
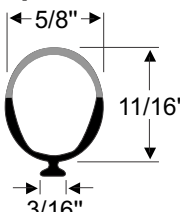
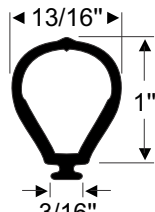
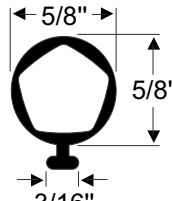
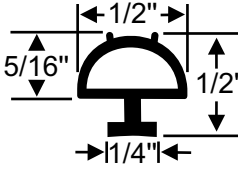
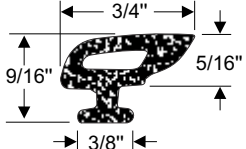

Cabin & Compartment Door Seals Fit-In-Track Seals

 30-0139-377 per/ft.	 70-0066-345 per/ft.	 30-0085-377 per/ft.	 70-4067-345 per/ft.	 30-0051-377 per/ft.	 70-4755-377 per/ft.
 70-3831-377 per/ft.	 70-3832-377 per/ft.	 70-3795-377 per/ft.	 70-3999-377 per/ft.	 70-3904-345 per/ft.	

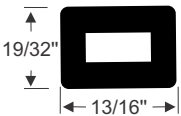
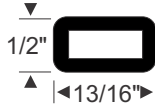
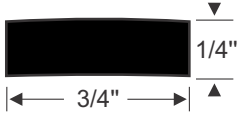
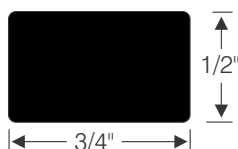
Dense Rubber Seals

 70-2396-377 • per/ft.	 70-1583-377 • per/ft.
 70-2424-377 • per/ft.	
 70-2422-377 • per/ft.	 70-2423-377 • per/ft.

T Rubber Seals

All sold per foot

Steele Rubber Product's dense T Rubber seals can be used in just about any application where rubber is held in place with a track or channel. Many boat shower doors utilize T Rubber seals.

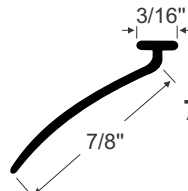
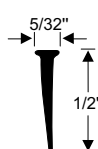
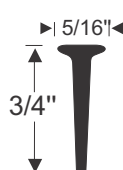
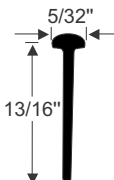
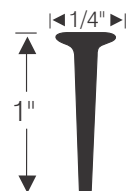
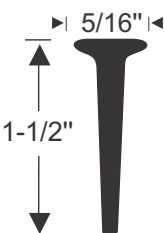
 70-3898-372	 70-4491-355	 70-0142-372	 70-3788-372	 70-1163-372	 19-0024-372
--	--	--	--	--	--

Metal Track



Pile Weatherstripping

Steele Rubber Product's pile weatherstripping works great as a GLASS SLIDER on many cabin entry doors & storage compartments.

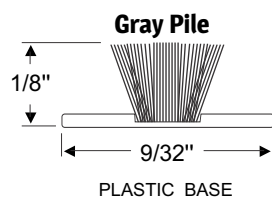
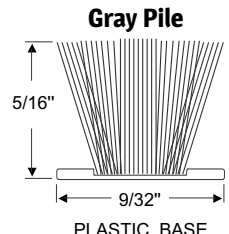
 Gray Pile 1/8" height 9/32" width PLASTIC BASE 70-3842-356 • 25ft. roll	 Gray Pile 5/16" height 9/32" width PLASTIC BASE 70-3843-356 • 25ft. roll
---	---

Call or visit our website for current pricing



Marine Weatherstripping

Window & Glass Seals

Designed for a variety of different Windows and Port Holes, Steele Rubber Product's seals are made with high quality materials-ensuring leak-proof mountings that keep the weather out when the port hole or window is closed. Inherently weather and UV resistant, these seals will provide a clean looking and durable finish that will last for years to come.



Window Glass Channel

<p>70-4607-357 • per/ft.</p>	<p>70-4501-357 • per/ft.</p>	<p>USES 30-0439-257 LOCKSTRIP 40-0496-357 • per/ft.</p>	<p>USES 60-0607-257 LOCKSTRIP 40-0548-357 • per/ft.</p>	<p>USES 60-0607-257 LOCKSTRIP 60-0082-357 • per/ft.</p>
<p>30-0044-357 • per/ft.</p>	<p>30-0507-357 • per/ft.</p>	<p>USES 60-0607-257 LOCKSTRIP 70-4774 • per/ft.</p>	<p>USES 60-0607-257 LOCKSTRIP 70-4775-357 • per/ft.</p>	<p>SELF LOCKING 70-4068-357 • per/ft.</p>
<p>Rigid Glass Run Channel</p> <p>70-0752-356 72" Strip</p> <p>70-3819-356 (2) 24" Strips</p>		<p>LOCKSTRIPS FOR USE WITH THE EXTRUSIONS ABOVE</p> <p>60-0607-357 • per/ft.</p> <p>30-0439-357 • per/ft.</p>		

*Glass Setting Channel

70-2169-357 • per/ft.
1/32" THICK

70-2170-357 • per/ft.
1/16" THICK

*FOLDS INTO U SHAPE AND SETS IN TRACK TO HOLD GLASS



Vent Hatch Window Weatherstrip

Slides in track to seal vent hatch windows. Made of a high-quality 100% EPDM dense rubber to provide superior durability.

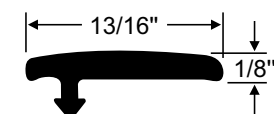

70-4492-345 • per/ft.

Sliding Glass Run Channel

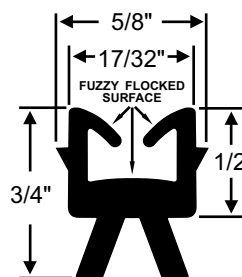

70-3977-356 • per/ft.

Sliding glass run channel with fuzzy lining to protect glass. Known to be an exact replacement on many Silverton, Sea Ray, Trojan, and Carver cruisers (among others). Our most popular sliding glass channel extrusion.

Window & Glass Seals

Flexible Glass Run Channel

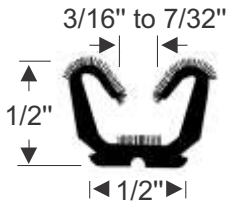

For 9/16" - 5/8" channel
70-3570-356 • 96" Strip

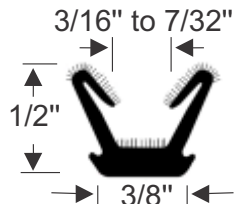

For 7/16" - 1/2" channel
70-3572-356 • 96" Strip

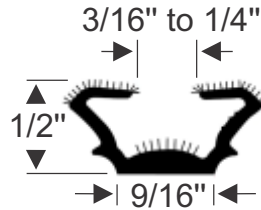

For 11/16" - 3/4" channel
70-3577-356 • 96" Strip

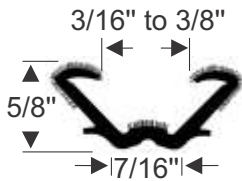

For 5/8" - 3/4" channel
70-3578-356 • 96" Strip

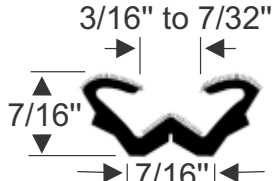

For 9/16" - 5/8" channel
70-3579-356 • 96" Strip

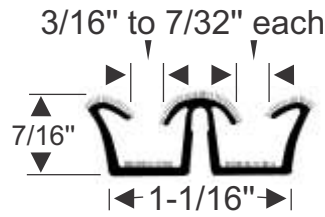

For 7/16" Individual channels
Or 15/16" channels w/o divider
70-3571-356 • 96" Strip

Port Window Seal

This weatherstrip is commonly found on boats with Bomar Oval Port Window assemblies. This is a "skirted" upgrade replacement weatherstrip for Bomar #50580012.

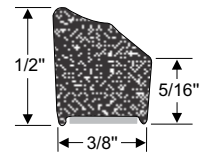

70-4756-354 • per/ft.

Windshield Frame Mounting Pad

GLUE-ON

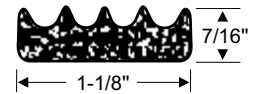

70-4798-347 • per/ft.

Center Window Weatherstrip

This weatherstripping supports the middle windshield glass on walkthrough windshields. The center window opens and closes against this weatherstripping. Developed with functionality in mind, this quality EPDM rubber seal protects against extreme weather and eliminates noise and vibration.

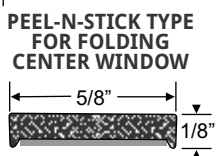
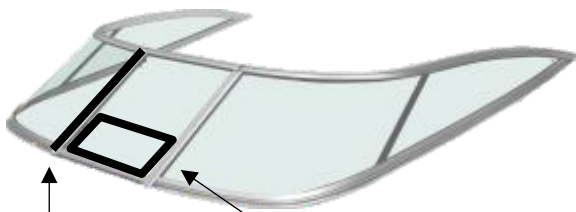

PEEL-N-STICK TYPE FOR FOLDING CENTER WINDOW

70-4205-372 • per/ft.

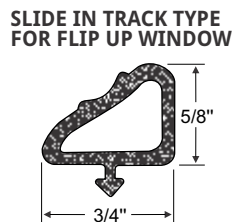

SLIDE IN TRACK TYPE FOR FLIP UP WINDOW

70-4311-357 • per/ft.

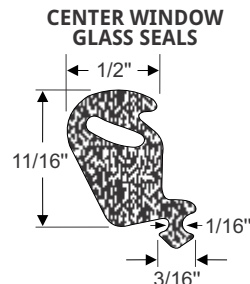

70-4705-347 • per/ft.

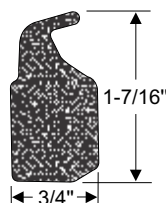

70-4753-357 • per/ft.

Windshield Frame Mounting Pads PEEL-N-STICK

A perfect replacement for a variety of metal windshield bases. Sponge or Dense rubber available and both are backed with 3M adhesive.



SPONGE

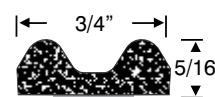

70-2683-345 • per/ft.

DENSE

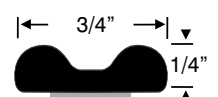

70-2676-357 • per/ft.

Call or visit our website for current pricing



Marine Weatherstripping

Window Edge Trim & Glazing

SOME EXTRUSIONS AVAILABLE IN WHITE RUBBER AS NOTED

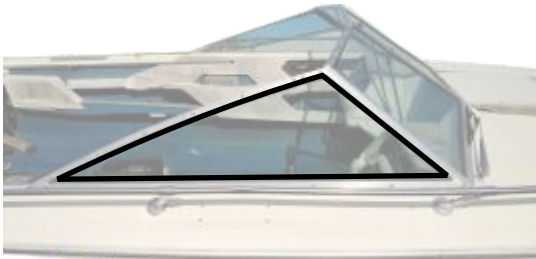

EXAMPLE OF GLASS EDGE TRIM/GLAZING

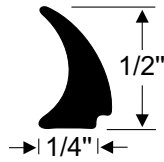

70-3814-357
per/ft.
70-4090-357
WHITE RUBBER

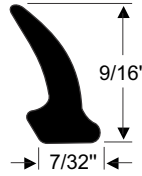

70-3829-357
per/ft.

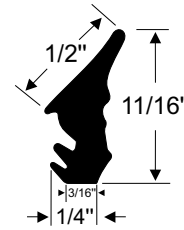

70-4694-357
per/ft.

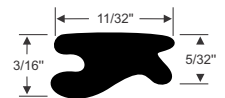

70-3825-355
per/ft.
70-4237-355
WHITE RUBBER

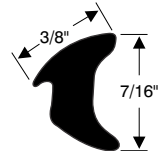

70-4680-357
per/ft.

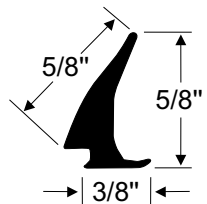

70-4608-357
per/ft.
70-4771-357
WHITE RUBBER

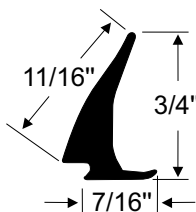

70-4816-357
per/ft.

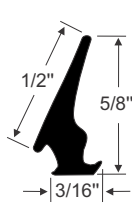

70-3794-357
per/ft.

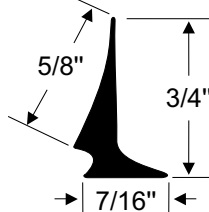

70-4792-357
per/ft.

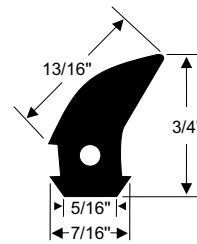

70-4857-357
per/ft.

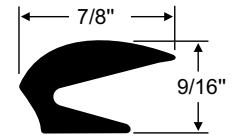

70-4351-357
per/ft.

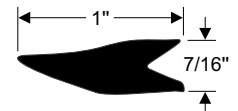

70-4078-357
per/ft.

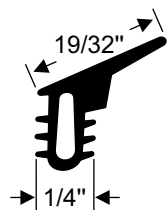

70-4077-344
per/ft.

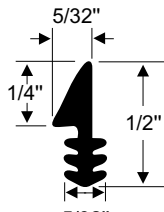

70-4593-357
per/ft.

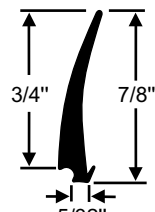

70-4301-357
per/ft.

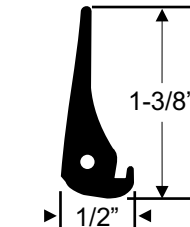

70-4591-357
per/ft.

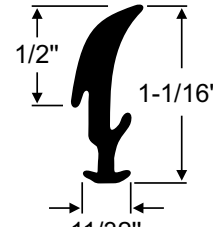

70-4499-357
per/ft.

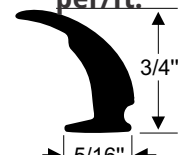

70-3857-356
per/ft.

70-4293-356
WHITE RUBBER

Windshield Screw Cover Seals

FITS IN BOAT WINDSHIELD
FRAMES TO HIDE
MOUNTING HARDWARE



EXAMPLE

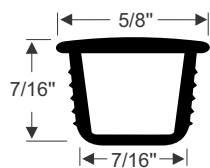

70-3824-355
per/ft.

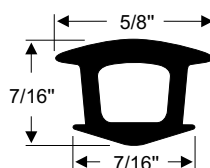

70-4300-357
per/ft.

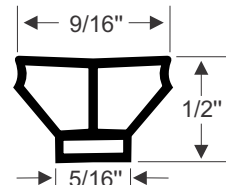

70-3813-340
per/ft.

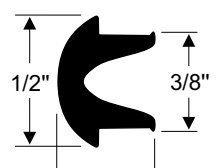

70-4534-357
per/ft.

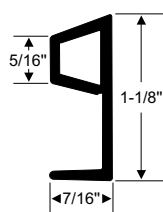

70-4752-340
per/ft.

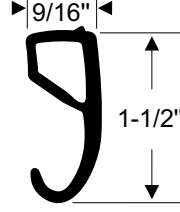

70-4665-340
per/ft.

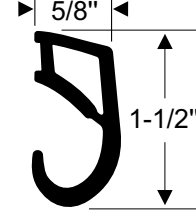

70-4666-340
per/ft.

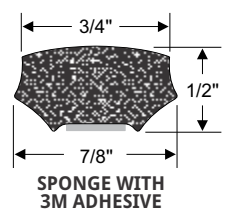

70-4770-340
per/ft.

SPONGE WITH
3M ADHESIVE

Hatch Seals

Quality hatch seals are where it's at - without them, the interior of your boat is exposed to the elements and pests. Durable, fully enclosed edge trim protects your watercraft from damage and you from sharp edges while standing up to the elements like a champ. Our seals feature the attachment convenience of either the weather resistant 3M Peel-N-Stick adhesive or the simple push-on design. Constructed out of weather and UV resistant EPDM, you'll experience a winning combination of fit and function!



Quality hatch seals are where it's at - without them, the interior of your boat is exposed to the elements and pests. Durable, fully enclosed edge trim protects your watercraft from damage and you from sharp edges while standing up to the elements like a champ. Our seals feature the attachment convenience of either the weather resistant 3M Peel-N-Stick adhesive or the simple push-on design. Constructed out of weather and UV resistant EPDM, you'll experience a winning combination of fit and function!

Sponge Rubber Peel-N-Stick Seals

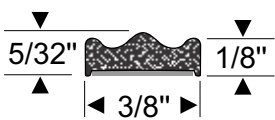

70-4624-377
per/ft.

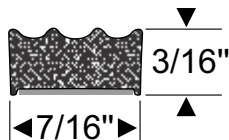

70-3846-377
per/ft.

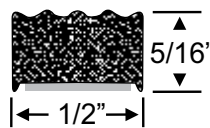

70-3672-377
per/ft.

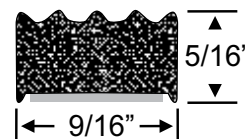

70-3673-377
per/ft.

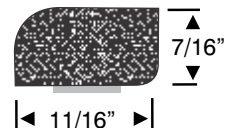

30-0243-377
per/ft.

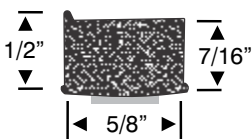

30-0144-377
per/ft.

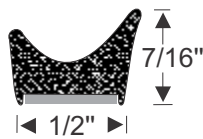

70-0331-372
per/ft.

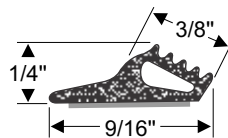

70-3858-377
per/ft.

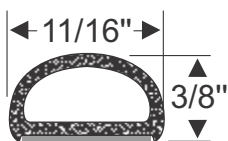

70-3848-377
per/ft.

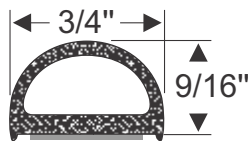

70-3859-377
per/ft.

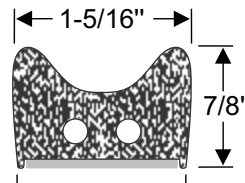

70-4644-345
per/ft.

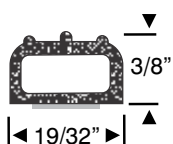

70-3676-377
per/ft.

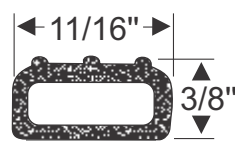

70-3849-377
per/ft.

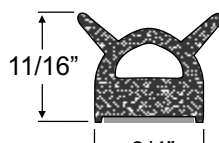

70-3802-377
per/ft.

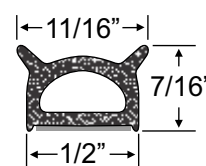

70-3847-377
per/ft.

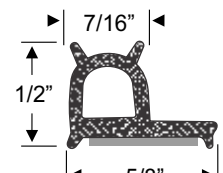

70-3852-372
per/ft.

Hatch Seals

Sponge Rubber Peel-N-Stick Seals

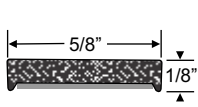

70-4205-372 • per/ft.

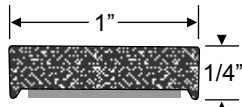

70-4204-377 • per/ft.

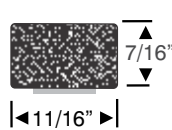

70-1105-377 • per/ft.

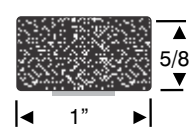

70-0129-377 • per/ft.

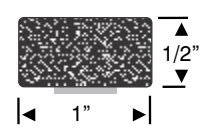

70-1106-377 • per/ft.

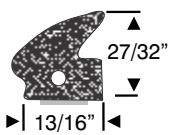

83-0123-377 • 10ft.

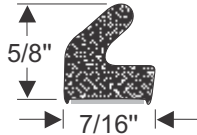

40-0480-377 • per/ft.

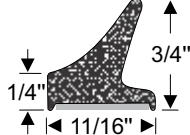

70-1437-377 • per/ft.

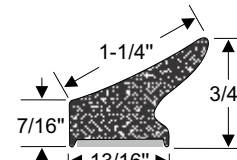

70-4504-377 • per/ft.

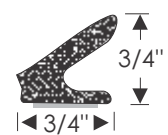

70-2401-377 • per/ft.

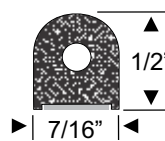

83-0107-377 • 5ft.
83-0108-377 • 10ft.
83-0130-377 • 15ft.
83-1019-377 • 30ft.

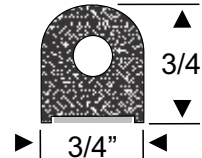

83-1023-377 • 5ft.
83-1024-377 • 10ft.
83-1025-377 • 15ft.
83-1026-377 • 30ft.

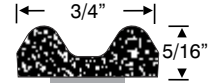

70-2683-345 • per/ft.

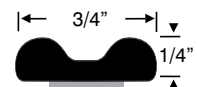

DENSE RUBBER
70-2676-357 • per/ft.

Sponge Rubber - Glue On Seals

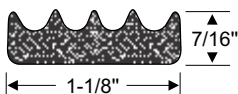

70-4798-347 • per/ft.

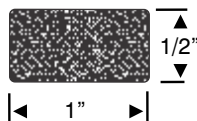

70-1106-340 • per/ft.

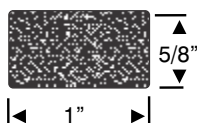

70-0129-345 • per/ft.

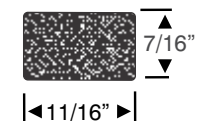

70-1105-340 • per/ft.

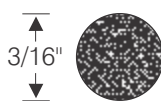

70-0884-357 • per/ft.



70-0957-357 • per/ft.

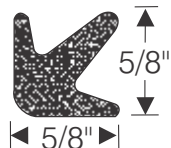

70-0219-372 • per/ft.

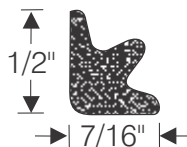

70-0311-372 • per/ft.

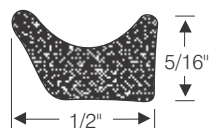

70-1789-377 • per/ft.



30-0470-377 • per/ft.

Dense Rubber - Glue On Seals

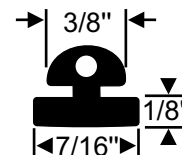

70-4079-345 • per/ft.

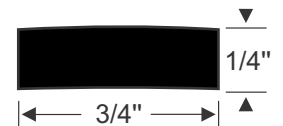

70-2424-377 • per/ft.

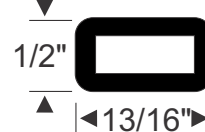

70-1583-377 • per/ft.



70-2423-377 • per/ft.

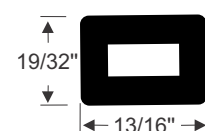

70-2396-377 • per/ft.



70-2422-377 • per/ft.

TOP BULB - Push-On Seals

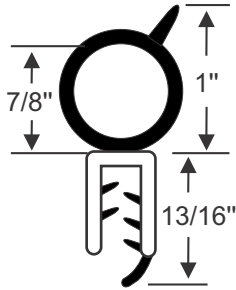

70-2831-345 • per/ft.

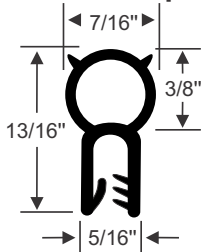

FOR 3/16" TO 1/4" EDGES
70-3854-345 • per/ft.

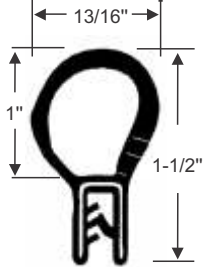

FOR EDGES UP TO 1/8"
70-3587-377 • 25ft. Roll

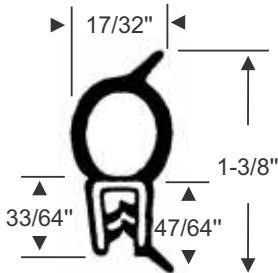

FOR 1/16" EDGES
70-3590-377 • per/ft.

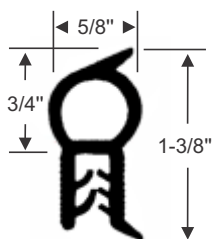

FOR 1/16" EDGES
70-3588-377 • 25ft. Roll

Hatch Seals

SIDE BULB - Push-On Seals

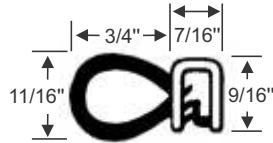

FOR 1/16" TO 1/8" EDGES
70-3582-377 • per/ft.

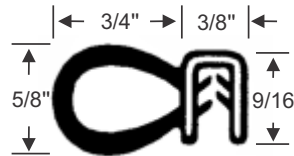

FOR 3/16" TO 1/4" EDGES
70-3583-377 • per/ft.

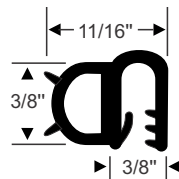

FOR 1/8" EDGES
70-3855-377 • per/ft.



FOR 3/16" TO 1/4" EDGES
70-3584-345 • per/ft.

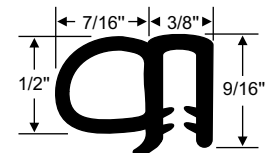

FOR 1/8" EDGES
70-3592-377 • per/ft.

WIPER - Push-On Seals

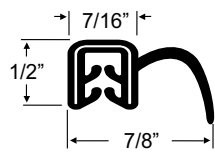

FOR 1/16" TO 1/8" EDGES
70-3801-377 • per/ft.

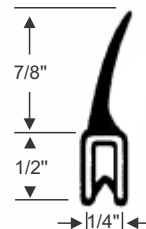

70-3591-377 • per/ft.

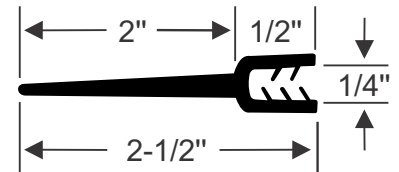

70-3710-377 • per/ft.

PRESS IN TRACK - HATCH SEAL

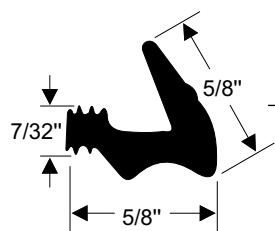

70-4685-377 • per/ft.



This Compartment Hatch Weatherstrip is known to fit the compartment doors of the following boat manufacturers: Avalon-Tahoe Pontoon, Barletta Pontoon, Bennington, Boston Whaler, Chaparral, Chris Craft, Contender, Crest Pontoon, Four Winns, Grady White, Harris Pontoon, JC Pontoon, Lowe Pontoon, Manitou Pontoon, Regal, Rinker, Robalo, Sea Ray, Tracker, Vanderbilt Pontoon, Veranda Pontoon and many others.



Marine Weatherstripping

Edge Trim

Flexible Push-On Edging Seals

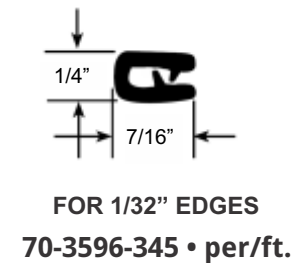
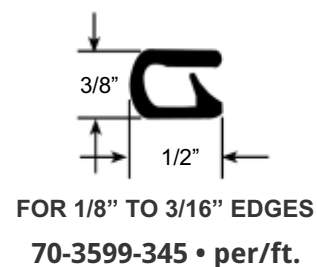
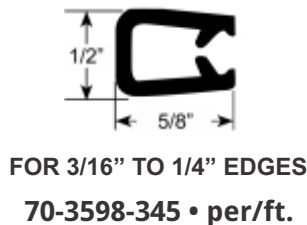
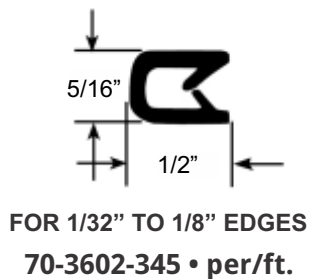
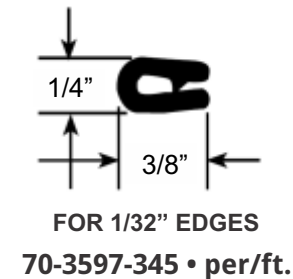
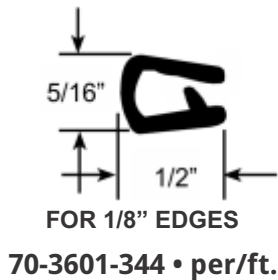
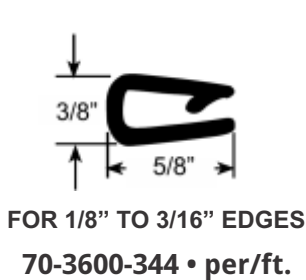

Rubber Glue-On Edging Seals

<p>DENSE</p> <p>70-3246-344 • per/ft.</p>	<p>SPONGE</p> <p>70-2118-345 • per/ft.</p>
<p>70-3166-344 • per/ft.</p>	<p>70-2119-345 • per/ft.</p>

Dock or Bunk Rail Guard Edging

Watercraft docks and bunk rails commonly feature bumpers of varying shapes and sizes. They are meant to help protect watercraft from damage caused by direct and glancing impacts.

Steele Rubber Products is proud to offer a high quality, 100% EPDM rubber Dock or Bunk Rail Guard Edging for these applications.

Visit steelerubber.com for for info!

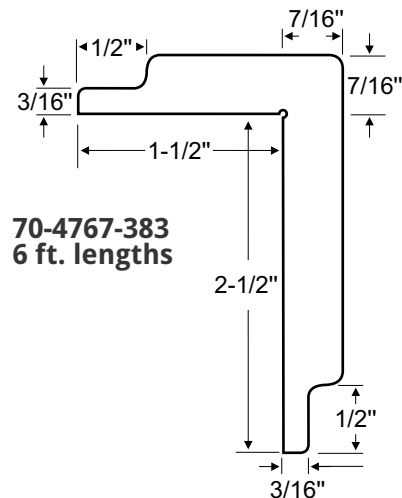

Rub Rail Insert Kits

- 100% marine grade EPDM rubber
- Superior durability
- Easier to install - no pre-heating of insert required
- Will not fade, shrink or crack
- Provides a clean, finished look
- Robust cushion to absorb impact

STEELE RUBBER PRODUCTS RUB RAIL INSERT



↑ COMMON RUB RAIL

Call or visit our website for current pricing

Ideal for rub rails commonly found on: Angler, Bayliner, Boston Whaler, Chapparral, Cobia, Contender, Four Winns, Glaston, Mako, Maxum, Scout, Sea Ray, Sportcraft, Trophy, Wellcraft and over 40 other boat manufacturers!

1/2" OR 3/4" ROUND

A GREAT ALTERNATIVE TO "ROPE" INSERTS

WHITE RUBBER ALSO AVAILABLE



1/2" ROUND

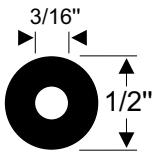

70-4064-347 - per/ft.
90-3351-347 - 50ft.
90-3352-347 - 70ft.
90-3353-347 - 200ft.

70-4690-347 - per/ft.
WHITE RUBBER

3/4" ROUND

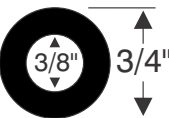

70-3976-347 - per/ft.
70-3992-347 - 50ft.
70-3993-347 - 70ft.

70-4686-347 - per/ft.
WHITE RUBBER

NOW AVAILABLE FEATURING THE MOST COMMON PROFILES - IN CONVENIENT LENGTHS

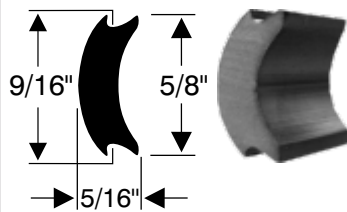

90-3335-347 - 50ft.
90-3336-347 - 250ft.

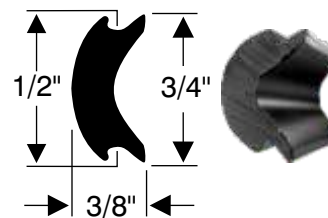

90-3338-347 - 50ft.

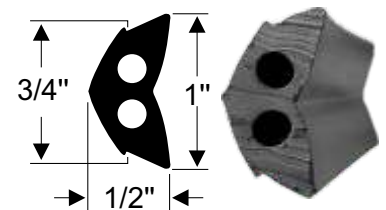

90-3331-347 - 50ft.
90-3332-347 - 70ft.
90-3333-347 - 200ft.

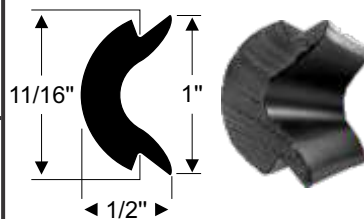

90-3340-347 - 50ft.
90-3341-347 - 70ft.
90-3342-347 - 200ft.
90-3343-347 - 300ft.

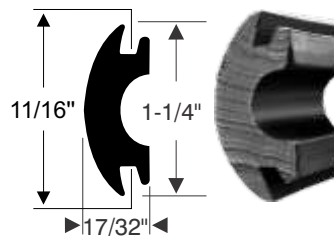

90-3358-347 - 50ft.

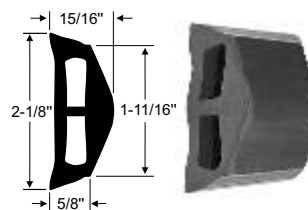

70-4361-347 - per/ft.

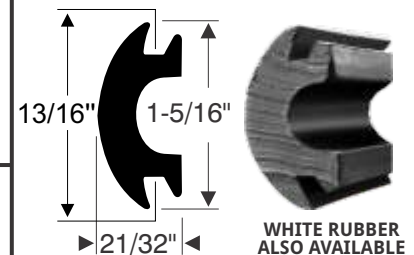

90-3345-347 - 50ft.
90-3346-347 - 70ft.
90-3347-347 - 250ft.

70-4688-347 - per/ft.
WHITE RUBBER



Insert Trim, Drip Rails & Misc. Parts

Protecting you and your boat - that's the job of drip rails, rub rails and insert trim. Our rails and trim are carefully constructed of high quality, weather and UV resistant EPDM rubber. This means years of precise fit and durable function that is easy to install.

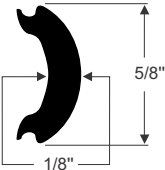
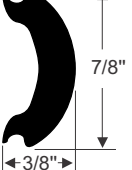
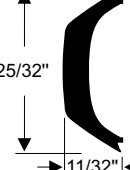
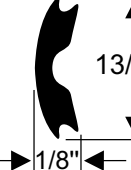

Insert Trim & Side Trim

 5/8" 1/8" FITS IN 1/2" TRACK 70-3782-340 per/ft. WHITE RUBBER 70-4687-340	 7/8" 3/8" WHITE RUBBER ALSO AVAILABLE FITS IN 5/8" TRACK 70-3979-340 per/ft. WHITE RUBBER 70-4689-340	 25/32" 11/32" 70-4069-340 per/ft.	 13/32" 1/8" 70-4592-344 per/ft.
--	---	--	--

**BODY BUMPER
SNAPS INTO METAL TRACK**

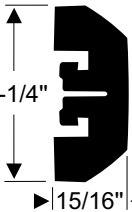
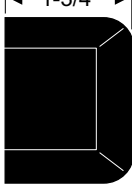
 2-1/4" 15/16" EXTRUSION 70-4093-347 per/ft.	 1-3/4" 2-1/4" END CAP 70-4177-347 • ea.
--	---

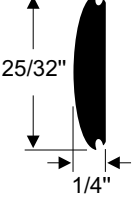
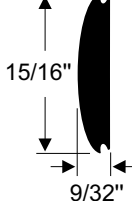
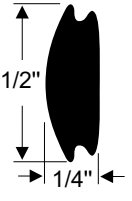
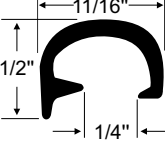
 5/8" 1/4" 70-4070-340 per/ft.	 25/32" 1/4" 70-4071-340 per/ft.	 15/16" 9/32" 70-4063-340 per/ft.	 1/2" 1/4" 70-4754-240 per/ft.	 11/16" 1/2" 1/4" 70-4594-344 per/ft.
--	--	---	---	--

Drip Rail

Drip rail seals are used to divert water away from doors and windows. Available in Black or White.

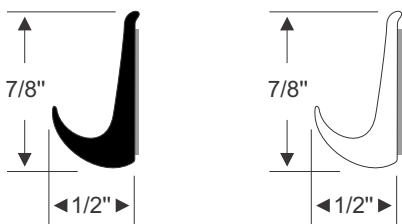

WHITE RUBBER

70-3851-360 • per/ft. **70-4056-360 • per/ft.**

Bulkhead Conduit



60-0653-347 • per/ft.

Dense rubber extrusion ideal for conduit use to prevent chafing wear of electrical lines.

Fuel Tank Support Straps

Supports the cushion strap for some marine fuel tanks.

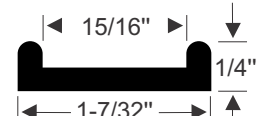

70-3612-347 • per/ft.

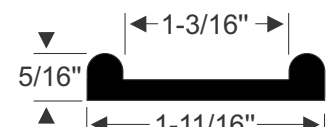

30-0482-347 • per/ft.

Dripper Guard



Available in Black or White

Dripper Guard prevents boat hull stains caused by boat thru-hull drains. It's perfect for any component on your boat that has a thru-hull fitting!

Ideal for preventing stains from air conditioner, sink, generator, shower, bilge pump, bait well, and sump pump thru-hulls.

Forget the boat hull cleaner and make your boat maintenance a breeze with Dripper Guard.

Black Small - 70-4029-308

White Small - 70-4028-308

Black Large - 70-4031-308

White Large - 70-4030-308

Black 3 Pack - 70-4033-308

White 3 Pack - 70-4032-308

Call or visit our website for current pricing

Universal Sponge Rubber

Great for universal mounting pads, anti vibration, and a variety of other uses!

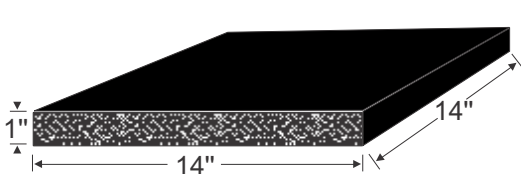

EACH
14"X14"X1" SPONGE PAD
70-3909-307

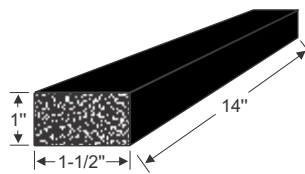

EACH
14"X1-1/2"X1" SPONGE BLOCK
70-3910-307

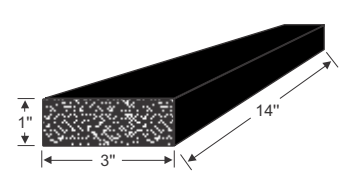

EACH
14"X3"X1" SPONGE BLOCK
70-3907-307

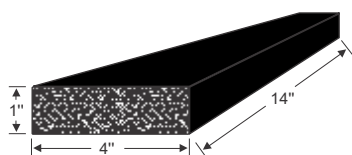

EACH
14"X4"X1" SPONGE BLOCK
70-3908-307

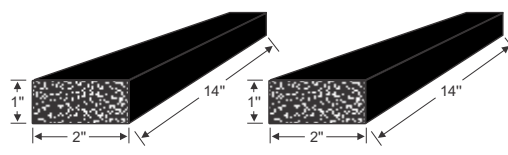

PAIR
14"X2"X1" SPONGE BLOCKS
70-3906-307

Bumpers, Grommets & Plugs

Steele Rubber Products uses the same precision molded high quality rubber in all of our bumpers, grommets and plugs as found in our seals. This ensures the optimal durability and fit for a variety of applications. The items presented here are only a sample representation of what we make. For additional sizes and profiles call 888-578-2237, visit us on-line at steelerubber.com or email us at marine@steelerubber.com today!

BUMPERS

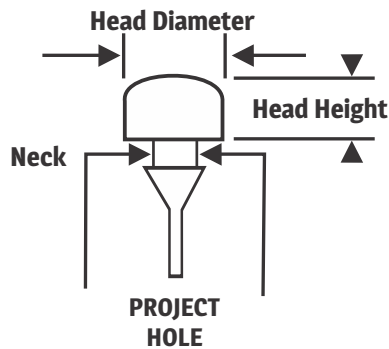

GROMMETS

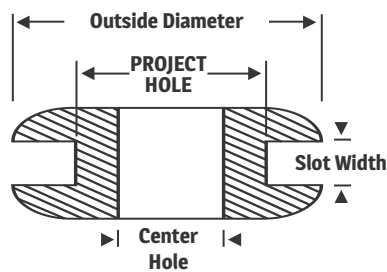

PLUGS

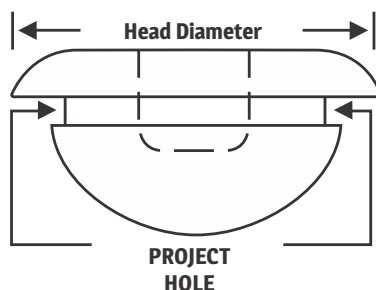
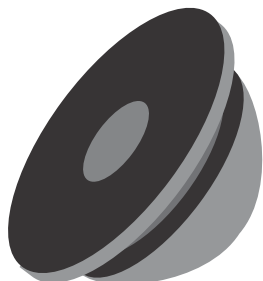

ROOF MOUNTED AC/HEAT PUMP GASKET

Unique high quality ONE-PIECE SPONGE EPDM replacement A/C, Heat-Pump Gasket. Fits most RV and marine A/C, heat-pump units including those made by Dometic and Coleman. One-piece design ensures no-leak functionality. Typically found on many houseboat brands. High-quality closed cell EPDM sponge rubber yields higher UV, ozone and weather resistant durability than what is originally supplied! Easy to use pressure sensitive adhesive backed.

STANDARD A/C GASKET KIT PART# 70-3905-307

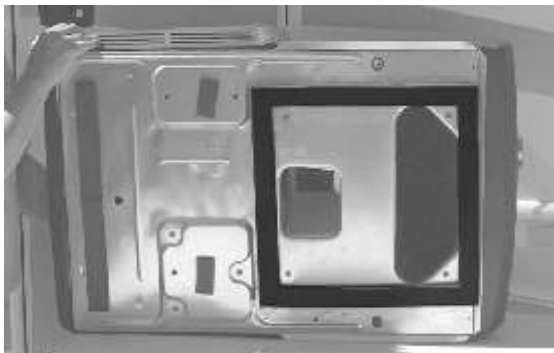
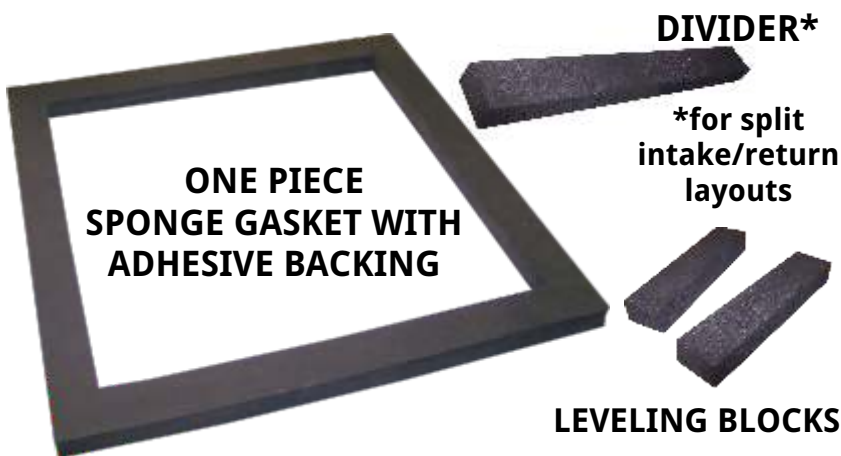

A/C GASKET PLENUM DIVIDER AVAILABLE SEPARATELY PART# 70-4284-307

This one piece angled 1" x 1/1/2" inch Plenum Divider strip is made of the same top quality materials as our A/C Gasket Kit. Serves as a high-quality one-piece divider for those RV roof-mounted A/C and Heat Pump units that require a division piece.

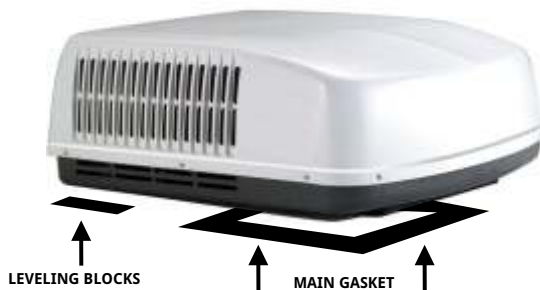

Call or visit our website for current pricing



Tools

Call or visit our website for current pricing



All Purpose Tool

High quality all purpose tool designed specifically to assist in the installation of window seal weatherstripping. 8" long, 4.875" blade and 2" hook.

94-0102-94



Glass Retainer Clip Tool

Reduces the risk of chips and scratches to glass windows caused by makeshift tools. This tool is specifically designed to fit trim clips over the studs and virtually eliminates glass breakage. It also dispenses with the need to remove rubber-like sealant surrounding the studs. A practical tool for placing trim retainer clips over headed studs welded around the body window shields.

94-0106-94



Trim Pad Removal Tool

Removes reveal moldings on rubber-less jobs. 9.5" long.

94-0108-94



Ball End Hook Tool

This Ball End Hook Tool assists greatly in the installation of window rubber on classic collector vehicles. This hook tool has a small, round steel ball on the end. Once the steel ball is inserted down into the rubber gasket, it is very difficult for it to come out. With the ball end design, should the tool indeed slip out of the gasket, there is less of a chance you will scratch the paint of the vehicle.

94-0101-94



Plastic Tool

This tool makes replacing gaskets easier. A handy multi-purpose tool to have. 8" x 11/16"

94-0110-00



Mini Hook Tool Set

This Mini Hook Tool Set offers four (4) different configurations to help you get under and pry up the smallest object.

94-0068-94



Safety Glasses

Reinforced plastic, clear lenses, and wraparound frame.

94-0109-94

Weatherstrip General Installation Kit



This Weatherstrip General Installation Kit has the items generally needed for the completion of a weatherstrip project. These kitted products are those chosen by the best professional builders and installation specialists in the restoration industry. We've put everything together in one simple and convenient kit.

- KIT INCLUDES:**
- 1 ea. 3M Weatherstrip Adhesive Black 96-8008-96
 - 1 ea. Locktite Super Bonder 495 96-0495-96
 - 1 ea. 3M Adhesive Cleaner 96-8987-96
 - 1 ea. Scraper / Tuck Tool 94-0110-00
 - 1 roll 1-1/2" Masking Tape 96-3431-96
 - 3 pr. Nitrile Disposable Gloves
 - 2 ea. Adhesive Applicator Sticks
 - 1 ea. Steele Rubber Products Decal

90-3355-390



3M Super Strength Molding Tape
Ideal for permanently attaching side moldings and trim to your vehicles, adding long-term protection and value. This tape features an extremely strong adhesive that's also easy to use. Just pull of the red liner and apply. 2 widths available.

96-3616-96 - 7/8" WIDE TAPE

96-3614-96 - 1/2" WIDE TAPE



3M Adhesion Promoter Sponge Applicator Packet
Formulated specifically for use with 3M Super Strength Molding Tapes, promotes a permanent bond with most low surface energy plastic materials commonly used in interior trim and exterior trim parts.

96-6396-96



Loctite Super Bonder 495

General purpose instant adhesive designed to bond rubber, metal, and plastic parts. Excellent for modified gaskets or rubber footage made of dense or sponge rubber.

96-0495-396 (3 gm. Tube)



3M Super Weatherstrip Adhesive (Yellow)*

For adhering all types of rubber weatherstripping. Light colored adhesive. Very fast drying, exceptional bonding strength.

96-8001-96 (5 oz. Tube)

3M Super Weatherstrip Adhesive (Black)*

It is a strong, flexible, rubbery adhesive that withstands vibration and extreme temperature variations. Because of its black color, clean-up is eliminated due to its blending in with the rubber.

96-8008-96 (5 oz. Tube)

3M Weatherstrip Adhesive (Black) *

Good general purpose rubber cement. Has quick tack, will not bleed through fabric.

96-8011-96 (5 oz. Tube)

3M Rubberized Undercoating *

Professional Grade Rubberized Undercoating produces a textured finish which resists chipping abrasion, exterior rusting and weathering. This coating provides one-coat build-up with no dripping, running or sagging. The undercoating is excellent for automotive undercarriages and for other uses including protection for wheel wells, fenders, quarter panels and more.

CANNOT BE SHIPPED VIA AIR

96-3584-96 (16 oz. Aerosol)



***State of California Only**  **WARNING:**

Products with an asterisk (*) can expose you to chemicals including toluene which is known to the State of California to cause cancer or birth defects or other reproductive harm. For more information, visit www.P65Warnings.ca.gov



Black Windshield and Body Sealant

A flexible Windshield and Body Sealant designed specifically for creating a watertight seal between windshield rubber gaskets and boat bodies.

96-8509-96



3M Adhesive Remover - Low VOC

3M Adhesive Remover - Low VOC is ideal for helping dissolve and remove dirt, grease, tar, and many non-curing type adhesives. Cleans without streaking and has proven to be excellent for surface preparation in adhesive applications. While this multipurpose cleaners is suitable for industrial use, it's also safe enough for everyday projects.

96-3618-96



3M Plastic and Emblem Adhesive

An excellent clear adhesive for plastic repair and emblem application. Use this strong, quick-drying adhesive for plastic or metal emblems, interior rigid plastic, tail light lenses, vinyl side moldings or upholstery.

96-8061-96 (5 oz. Tube)

3M Urethane Adhesive*

Auto Glass Urethane Windshield Adhesive is a medium viscosity, one-part, moisture-curing urethane adhesive. It is formulated to be fast-curing and non-sagging for rapid results and a clean and simple application process. The features of this windshield adhesive produce high-strength material designed to bond and seal vehicle windshields, backlights and sidelights.

96-8693-96 (10.5 oz. Cartridge)



Call or visit our website for current pricing



Check out our “How To” videos!

Need help installing your weatherstripping?
Visit our youtube channel and we'll show you how to do it.
Our “How To” videos will definitely help you get started in
the right direction.

Visit www.youtube.com/steelerubberproducts



steelerubber.com/install
youtube.com/steelerubberproducts

Custom/Contract Work Available!

Since 1958, Steele Rubber Products has been carefully crafting seals and weatherstripping to meet the desires and needs of our customers. We pride ourselves in making parts that are often better than the originals and provide superior solutions to unique problems. As such, Steele Rubber Products offers custom and contract work. Whether your need is a unique part or a unique partnership, Steele Rubber Products is ready to stand with you in getting the job done – and done right. We treat each customer’s project as our own. How may we help you with yours? Contact us today – we look forward to speaking with you.



CONTACT US

ONLINE - CHAT
STEELERUBBER.COM

TOLL FREE
888-578-2237

EMAIL
marine@steelerubber.com



CUSTOMER SERVICE

Steele provides quality service both before and after your purchase. To place orders, check order status, request a catalog or for any other inquiries, contact us Mon-Friday 8am-6pm Eastern Standard Time at 888-578-2237 (toll free) or 704-483-9343 (local). You can also contact us 24/7 at contact@steelerubber.com.

RETURN POLICY

In the event that you need to return any products, contact us directly Monday-Friday 8am-6pm at 800-461-7089 (toll free) or 704-483-9343 (local) and our Customer Service Representatives will provide you with a return merchandise authorization number (RMA) and instructions for returning any part(s) to us.

Note:

Parts are accepted for return only in the units purchased and with the original invoice. We cannot accept refund packages sent COD or any method for which there is a charge to us. If a part is altered or damaged in any way, we will not be able to accept it for return. We cannot accept returns of products not purchased directly from Steele Rubber Products. Shipping and handling charges are not refundable. To view our full return policy visit: steelerubber.com/returns

PARTS AVAILABILITY

New parts are constantly added to our inventory. Visit us online for current availability of all products.

DELIVERY OF PARTS

We cannot guarantee a continuous roll of any extrusion in this catalog when ordered in bulk. We will do our best to ensure that each strip is as long as possible to minimize scrapage for you. Therefore, we reserve the right to deliver your parts in multiple lengths to meet your total purchase requirements.

USE OF PARTS

These parts are not recommended for specific usage. We are not responsible for damages caused by incorrect installation, abuse, mishandling, accidents or normal wear. Nor will Steele be responsible for labor charges, inconveniences, or any other expenses associated with parts bought through resellers or Steele.

SATISFACTION GUARANTEE

We offer a 100% satisfaction guarantee on all parts manufactured by and purchased from Steele Rubber Products.

COPYRIGHT SECTION

Contents 2024© Steele Rubber Products, Inc. Printed in the USA. This catalog may not be reproduced without written permission. All drawings, photographs, and graphic images contained in this catalog are the property of Steele Rubber Products and cannot be reproduced without written permission. The contents of this catalog should not be altered in any way for commercial or other use.

PAYMENT INFORMATION



For full disclosure of Steele Rubber Products policies please visit us online at steelerubber.com. If you do not have access to the internet and would like a printed version of our policies, please call 888-578-2237 (toll free) or 704-483-9343 (local).

Please visit our website for the most up-to-date product information.



steelerubber.com

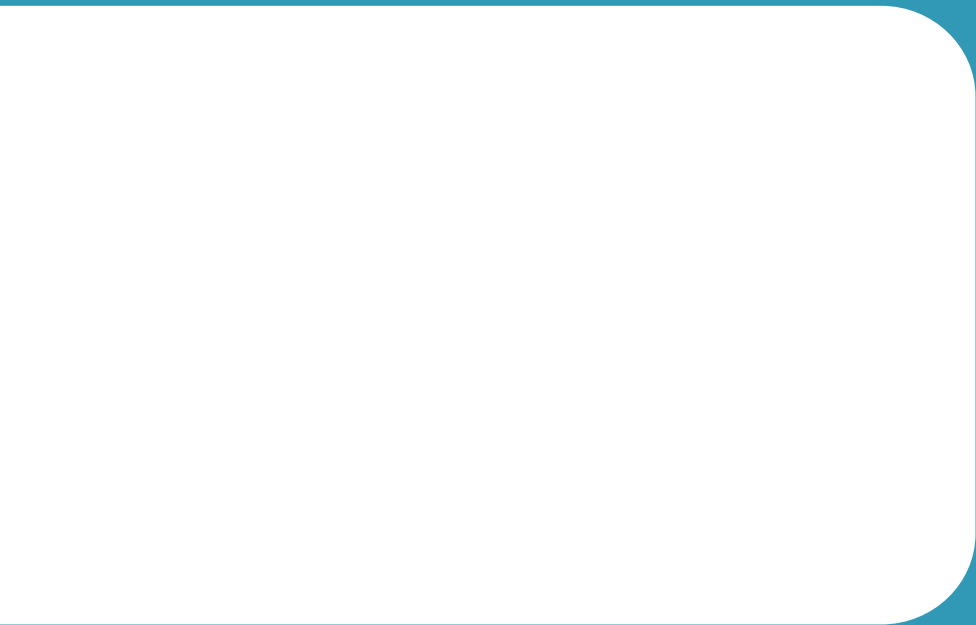

Since 1958

Steele Rubber Products
6180 E NC 150 HWY
Denver, NC 28037



steelerubber.com

REVISED
4/16/24